

# MECANISMO FUENTES 38

## FUENTES 38 MECHANISM

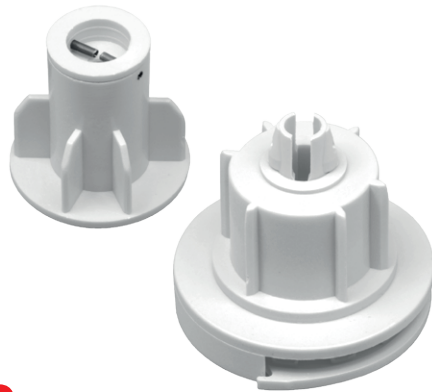

hasta / up to  
**3.5 kg**

Mecanismo Fuentes 38. Instalación rápida gracias a su sistema de muelle. Transmisión directa.

Fuentes 38 mechanism. Quick installation due to its spring system. Direct drive.

60 x 56 x 55 mm  
100 u/box 66 g/set  
PA, POM

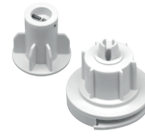

blanco - white 12017916



beige 12017115



gris - grey 12017867



negro - black 12017964



blanco - white 12018916

beige 12018115

gris - grey 12018867

negro - black 12018964

Soportes Fuentes 38, para instalación en pared, techo o hueco indistintamente.

Fuentes 38 brackets, for wall, ceiling or hollow installation indistinctly.

74 x 68 x 22 mm 200 u/bag 15,8 g Steel



blanco - white 12019916

beige 12019115

gris - grey 12019867

negro - black 12019964

Tapa para los soportes Fuentes 38. Pueden colocarse tras la instalación de los soportes.

Cover for the Fuentes 38 brackets. They can be placed after the installation of the brackets.

53 x 66 x 7 mm 250 u/bag 8,8 g ABS

novedad / new

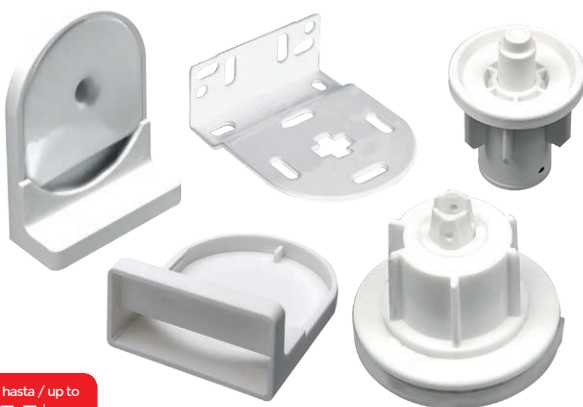

hasta / up to  
**3.5 kg**

Set de mecanismo Fuentes 38 y soportes con tapa con cubretornillos integrado.

Fuentes 38 mechanism and brackets set with special covers that hides the screws.

74 x 68 x 22 mm  
50 u/bag 13,8 g/set  
PA, POM, Steel

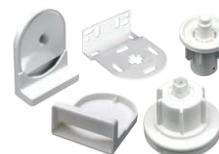

blanco - white 12055900



beige 12055115

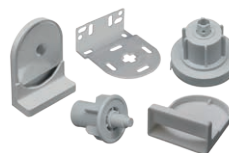

gris - grey 12055867



negro - black 12055964

# MECANISMO FUENTES 38

## FUENTES 38 MECHANISM

### Soportes especiales y accesorios / Special brackets and accessories



izquierda  
left side 12002126



derecha  
right side 12002125



ambos lados  
booth sides 12002124

Juego de soportes Duo que permite el montaje de dos cortinas en tandem. La distancia entre tejidos es de 65 mm.

Set for assemble a Duo system that allows you to install two blinds in tandem. The distance between blinds is 65 mm.

118 x 104 x 28 mm  
50 sets/box 181,2 g/set  
Steel



blanco - white 12002128

Juego de tapas para soportes Fuentes 38 Duo.

Set of covers for Fuentes 38 Duo brackets.

125 x 110 x 8 mm 100 sets/bag 33 g ABS



blanco - white 12002123

Soporte central Duo con transmisión. Para 4 estores con solo 2 mecanismos. Incluye conteras especiales.

Middle bracket for Duo blind installation. For 4 blinds with only 2 mechanisms. Includes special idlers.

118 x 104 x 28 mm 50 u/bag 180 g ABS, Steel



blanco - white 12002120

Soporte cental con transmisión. Para 2 estores y 1 mecanismo. La distancia entre tejidos es de 25 mm.

Middle bracket with transmission. For 2 blinds with 1 mechanism. The distance between blinds is 25 mm.

74 x 68 x 24 mm 100 u/bag 96 g POM, PS, Steel

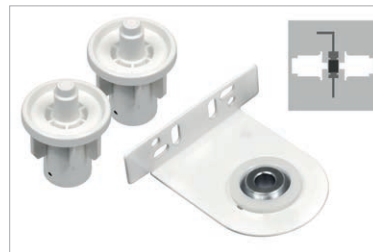

blanco - white 12002121

Soporte cental sin transmisión. Para 2 estores y 2 mecanismos. La distancia entre tejidos es de 25 mm.

Middle bracket without transmission. For 2 blinds with 2 mechanisms. The distance between blinds is 25 mm.

74 x 68 x 24 mm 100 u/bag 73 g POM, PS, Steel



derecha right 12002079  
izquierda left 12002082

Mecanismo de compensación por muelle de torsión, para estor de gran superficie (de 4 a 7 m<sup>2</sup>). Ancho mínimo de 65 cm.

Compensation mechanism with torsion spring, for large area rollers (from 4 to 7 m<sup>2</sup>). Minimum width 65 cm.

140 x 50 x 540 mm 1 u/box 1,7 Kg PVC, Spring steel

# MECANISMO FUENTES 38

## FUENTES 38 MECHANISM

### Opciones de instalación / Mounting options

**A. Doble con transmisión (2 estores en línea, 1 mecanismo)**  
 Double with transmission (2 blinds in a row, 1 mechanism)

lado del mecanismo  
mechanism side

componentes necesarios  
required accessories

cualquier lado  
either side

12002120 

**B. Doble sin transmisión (2 estores en línea, 2 mecanismos)**  
 Double without transmission (2 blinds in a row, 2 mechanisms)

lado del mecanismo  
mechanism side

componentes necesarios  
required accessories

ambos lados  
both sides

12002121 + 12017916 

**C. DUO (2 estores en paralelo, 2 mecanismos)**  
 Duo (2 blinds in parallel, 2 mechanisms)

lado del mecanismo  
mechanism side

componentes necesarios  
required accessories

ambos lados  
both sides

12002124 

dos a la derecha  
two at right side

12002125 

dos a la izquierda  
two at left side

12002126 

**D. Duo doble con transmisión (4 estores en línea y en paralelo, 2 mecanismos)**  
 Double Duo with transmission (4 blinds in a row and in parallel, 2 mechanisms)

lado del mecanismo  
mechanism side

componentes necesarios  
required accessories

ambos lados  
both sides

12002124 + 12002123 

dos a la derecha  
two at right side

12002125 + 12002123 

dos a la izquierda  
two at left side

12002126 + 12002123 

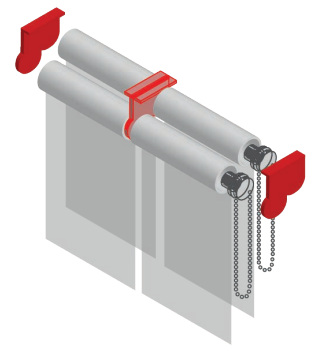
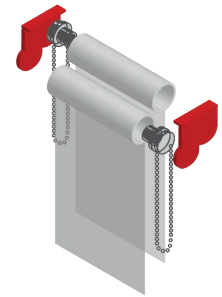
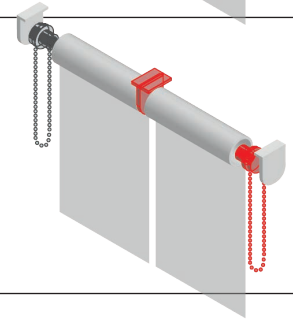
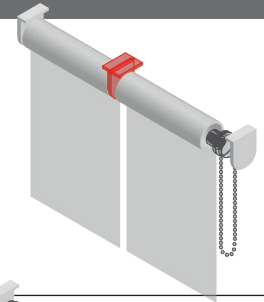

Válido para... / Valid for...

ESTOR ENROLLABLE / ROLLER BLINDS

FUENTES 38