





CONTRAPESO RANURADO

HOLLOW BOTTOM BAR

Contrapeso en aluminio. Su diseño sencillo y de líneas suavizadas le permiten integrarse a cualquier ambiente.

Aluminum bottom bar. Its simple design and soft lines allow it to integrate into any environment.

-  10 mm x 28 mm x 5,8 M
-  38 bars/box  231 g/m
-  Aluminium (6063-T5)
-  Ext. 19003003

blanco - white 11813900

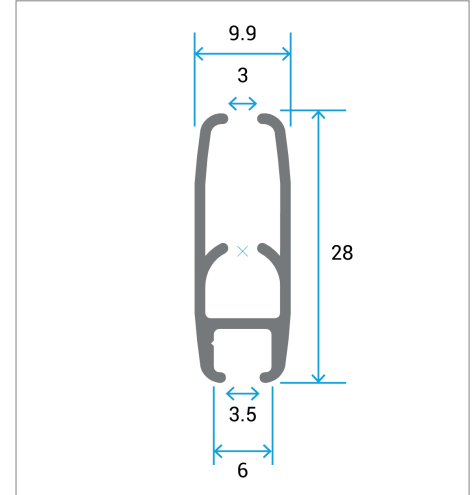

Uniones a tejido válidas / Valid fabric holders



3 MM Ø	11801010
4 MM Ø	11801011

Varilla cilíndrica fabricada en Fibra de Vidrio. Para la unión del tejido a perfil. Disponible en varios anchos.

Fiberglass rod. For attaching the fabric to profiles. Available in multiple widths

-  3-4 mm x 600 M
-  600 m/roll
-  14 Kg/roll
-  Fiberglass

Tapones / End caps

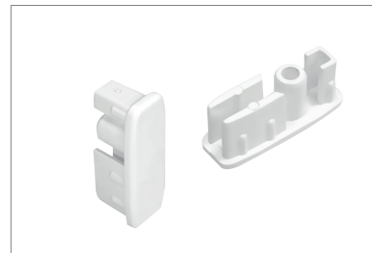

blanco - white	12005900
beige	12005115
gris - grey	12005867
negro - black	12005964

Tapón para contrapeso Ranurado.

End cap for Hollow bottom bar.

-  10 x 30 x 12,5 mm
-  1000 u/bag
-  1.8 g
-  PA

Válido para... / Valid for...

ESTOR ENROLLABLE / ROLLER BLINDS

- MELGAR 43
- MELGAR 43 PLUS
- MELGAR 43 PRO
- MELGAR 56
- FUENTES 38
- FUENTES 45

ESTOR COFRE / BOX ROLLER BLINDS

- 73 NEVAFLEX
- 85 MELGAR
- 90 MELGAR

