

COFRE 90 MELGAR

BOX 90 MELGAR

Cofre de aluminio donde el mecanismo y el rollo se insertan. De esta manera quedan protegidos y todo el sistema queda oculto.

Aluminium box where the mechanism and roll are inserted. In this way are protected and the entire system remains hidden.

-  84 x 86 mm x 5,8 M
-  8 bars/box  686 g/m
-  Aluminium (6063-T5)
-  Ext. 90012



blanco - white 11912900

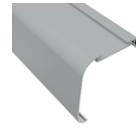

gris - grey 11912740

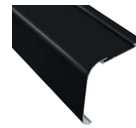

negro - black 11912905

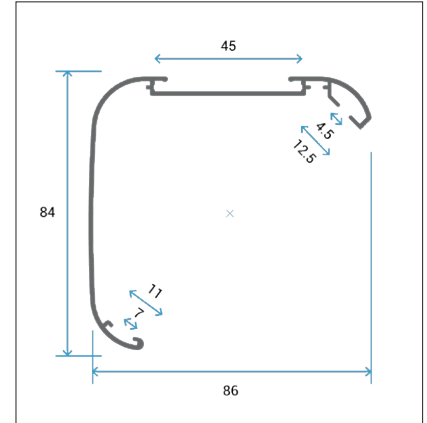

Uniones a tejido válidas / Valid fabric holders



transparente clear 11801060

Perfil goma de coextrusión 9 mm. Para la unión del tejido a perfil. Termosoldable.

Coextruded rubber profile 9 mm. For attaching the fabric to profiles. Heat welding allowed.

-  9 x 18 mm x 300 M
-  300 m/roll
-  20Kg/roll
-  Coextruded PVC

Tapas / Caps



blanco - white 12135900

gris - grey 12135740

negro - black 12135964

Tapa plástica para cofre 90. Fijación a presión y con tornillo.

Plastic cap for the box 90. Pressure and screw fixing.

-  25 x 38 x 46 mm
-  400 u/bag
-  41 g
-  Steel, POM

Soportes / Brackets



chromo chrome 12101026

Soporte techo/pared para el cofre 90-galería 88. Sistema de muelle para fácil montaje y una óptima fijación.

Wall/ceiling bracket for the box 90-rail 88. Its spring system allows easy installation and optimal attachment.



-  30 x 78 x 37 mm
-  400 u/box
-  41 g
-  Steel, POM



chromo chrome 12101025

Soporte techo para el cofre 90-galería 88. Sistema de muelle para fácil montaje y una óptima fijación.

Ceiling bracket for the box 90-rail 88. Its spring system allows easy installation and optimal attachment.

-  30 x 78 x 8 mm
-  400 u/box
-  17 g
-  Steel, POM

Válido para... / Valid for...

ESTOR COFRE / BOX ROLLER BLINDS

90 MELGAR